

NEW

LEDliner70

Suspended & Ceiling Mounted

Aluminium extruded profile 71x73 mm for ceiling or suspended mounting solutions. Strong attention is given to thermal management (reduction of heat). LEDliner70 offers the latest and best performing LED lighting technology using Philips LED modules. These modules can be used as direct lighting or combined direct/indirect lighting.

Average weight of equipped profile:
4.3kg/m

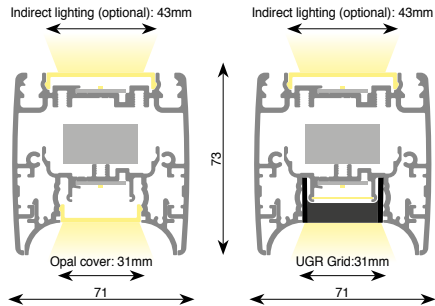

Possibilities

Mounting:

- Suspended
- Ceiling mounted

Modules:

- Linear LED modules - Down
- Linear LED modules - Up/Down

Options/Accessories

- Emergency lighting

5 Years **Philips** Warranty

Index

Custom made:

- Linear modules Down.....p.318
- Linear modules Up & Down 1Cp.320
- Linear modules Up & Down 2C.....p.322

Ready to go:

- Suspended Downp.268, 269
- Suspended Up & Down 1C.....p.272, 273
- Suspended Up & Down 2C.....p.274, 275
- Ceiling Mounted.....p.270, 271

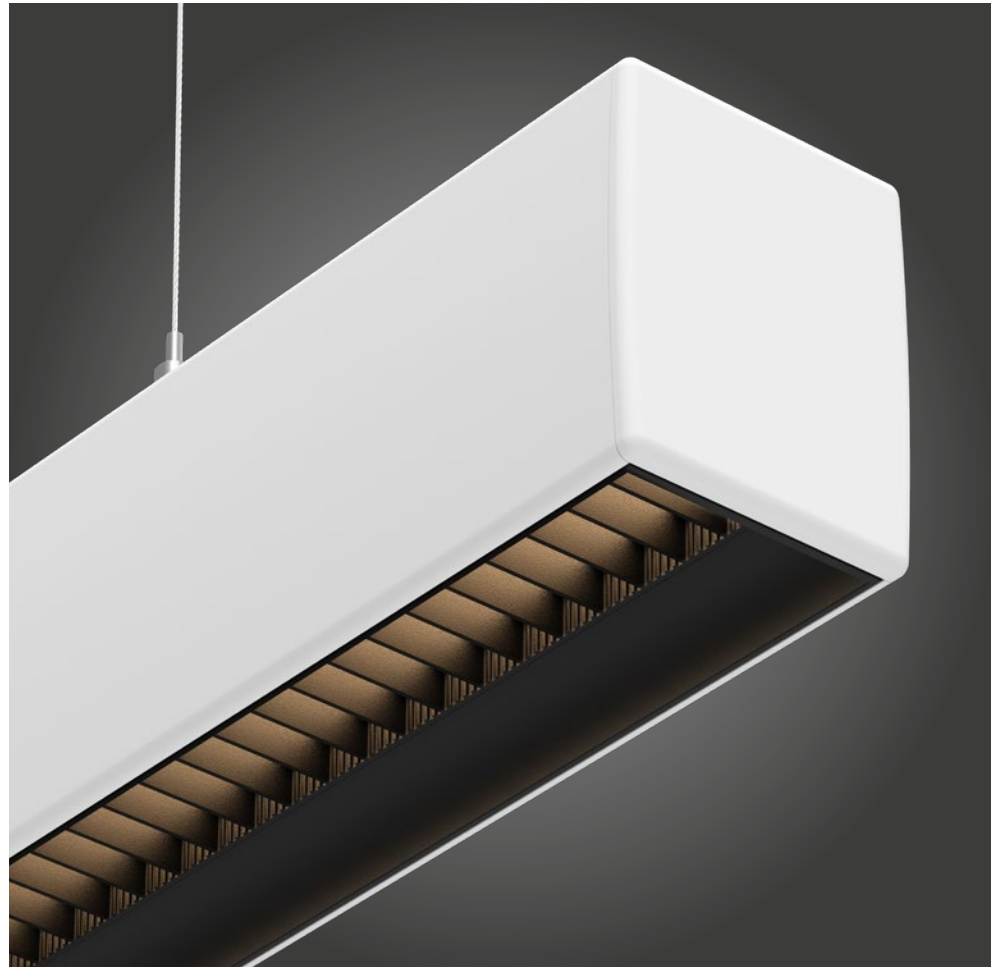

Available colors

01 White Matt Text.	03 Black Matt Text.	18 Grey Matt Text.	11 Black Matt + Gold	05 White +Black Matt Text.
07 Anthracite Matt Text.	25 Smoked Brown	16 Gold (Optional)	12 White Matt + Gold	32 Gold + Black Matt
	See p.264 and p.265 for a more detailed overview of color combinations.			
28 Grey + Black Matt				

LEDliner70 - Basic components

Profile housing

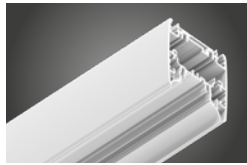

Profile /meter (max. length single piece 3400mm)

Matt White Texture	2240.00.01
Matt Black Texture	2240.00.03
Matt Anthracite Texture	2240.00.07
Matt Grey 9006 Texture	2240.00.18
Smoked Brown Texture	2240.00.25
Matt White + Black Texture	2240.00.05
Matt White Texture + Gold	2240.00.11
Matt Black Texture + Gold	2240.00.12
Other RAL Colors	650.99.00 on request

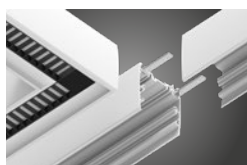

Connector

90°	2241.00.00
180°	2242.00.00
Custom made	2178.00.00



End Cap without visible screws (1 piece)

Matt White	2243.00.01
Matt Black	2243.00.03
Matt Anthracite	2243.00.07
Matt Grey 9006	2243.00.18
Smoked Brown Text.	2243.00.25

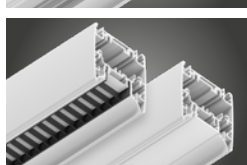

LEDliner70 Grid+Cover /meter

Black grid (UGR<19)	2245.00.03
Gold grid	2245.00.16
Opal cover	2244.00.00
Alu cover	2246.00.00

Alu cover painted in color of profile
Other colors on request

Mounting

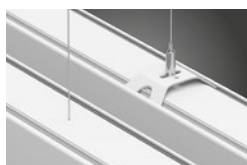

Suspension Set (more info see p.266)
Incl ceiling fixation, min suspension height: 75mm

2000mm Bracket	2247.00.00-2
4000mm Bracket	2247.00.00-4
2000mm Invisible	2248.00.00-2
4000mm Invisible	2248.00.00-4

0-1800mm: 2 suspensions required
1801mm-3400mm: 3 suspensions required
3401mm-4200mm: 4 suspensions required
4201mm-6700mm: 6 suspensions required

Linear Modules

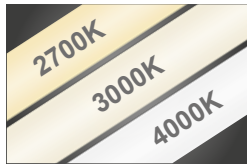

Linear LED Module Philips Fortimo 1100lm/ft

Down see p.318-319
Up&Down Single Circuit see p.320-321
Up&Down Double Circuit see p.322-323

Available linear modules:
Ra80 - 3000K / 4000K
Ra90 - 2700K / 3000K / 4000K

Optional



Emergency module for linear modules

3Hrs Standard	659.24.LED-3
3Hrs Extended (DALI)	659.26.LED-3

More info see p.339

Tridonic BasicDIM module (Casambi)

Casambi module*	661.26.00
-----------------	-----------

Only in combination with DALI drivers
One module for each driver required
Module is built into luminaire

Electrical

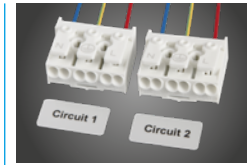

Extra circuit

Per meter	
Extra circuit /m	650.00.00

When multiple modules are used in one profile, modules can be switched individually using multiple circuits.
Length of extra circuit equals the full length of the profile.



Ceiling Connecting Box Square 67x67x40mm*

Matt White Texture	2150.00.01
Matt Black Texture	2150.00.03
Matt Anthracite Texture	2150.00.07
Matt Grey 9006 Texture	2150.00.18
Smoked Brown Texture	2150.00.25



Recessed Connecting Box Ø80mm*

Matt White Texture	2152.00.01
Matt Black Texture	2152.00.03
Matt Grey 9006 Texture	2152.00.18

Cut-out: Ø68mm (depth min. 60mm)
Other Colors on request
Detailed view: see p.346



Trimless Connecting Box Ø80mm*

Matt White Texture	2153.00.01
Matt Black Texture	2153.00.03
Matt Grey 9006 Texture	2153.00.18

Cut-out: Ø85mm (depth min. 60mm)
Other Colors on request
Detailed view: see p.346



White Textile Cable Supply

3x0.75mm ² - 2000mm	2154.00.01
3x0.75mm ² - 4000mm	2155.00.01
5x0.75mm ² - 2000mm	2156.00.01
5x0.75mm ² - 4000mm	2157.00.01
7x0.75mm ² - 2000mm	2158.00.01
7x0.75mm ² - 4000mm	2159.00.01



Black Textile Cable Supply

3x0.75mm ² - 2000mm	2154.00.03
3x0.75mm ² - 4000mm	2155.00.03
5x0.75mm ² - 2000mm	2156.00.03
5x0.75mm ² - 4000mm	2157.00.03
7x0.75mm ² - 2000mm	2158.00.03
7x0.75mm ² - 4000mm	2159.00.03

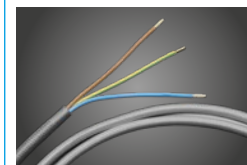

Grey Textile Cable Supply

3x0.75mm ² - 2000mm	2154.00.18
3x0.75mm ² - 4000mm	2155.00.18
5x0.75mm ² - 2000mm	2156.00.18
5x0.75mm ² - 4000mm	2157.00.18
7x0.75mm ² - 2000mm	2158.00.18
7x0.75mm ² - 4000mm	2159.00.18

*Cable supply shown in photo not included

LEDliner70 UGR

Color possibilities



01 White Matt Texture
Standard



05 White + Black Matt Texture
Standard

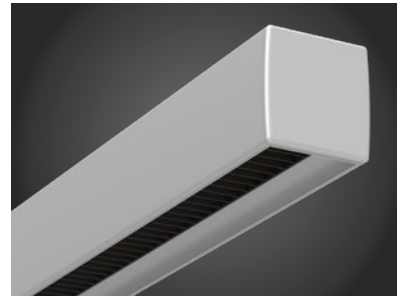

18 Grey Matt Texture
Standard

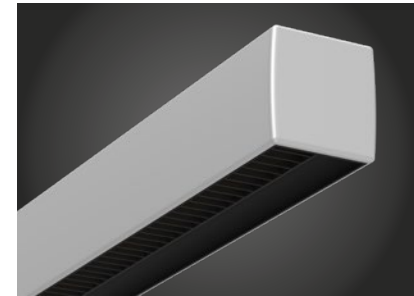

28 Grey + Black Matt Texture
Standard

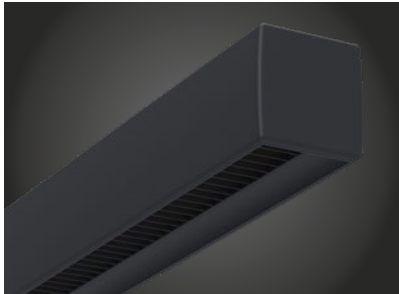

07 Anthracite Matt Texture
Standard



03 Black Matt Texture
Standard

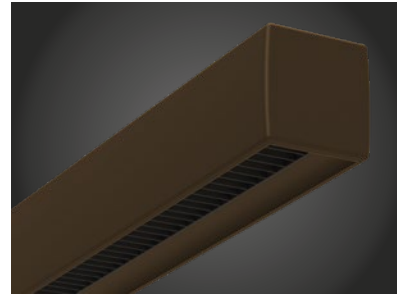

25 Smoked Brown Matt Texture
Standard

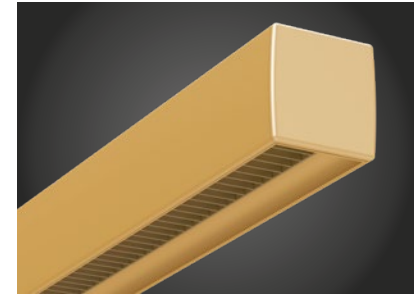

16 Gold Matt*

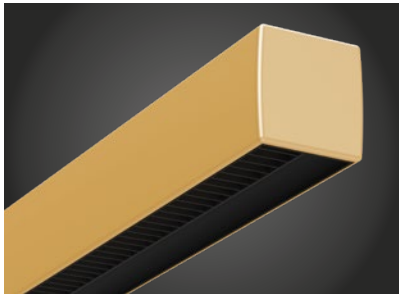

32 Gold + Black Matt T2

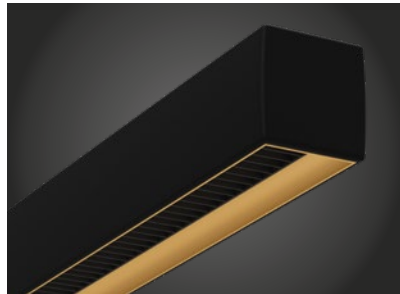

11 Black + Gold Matt

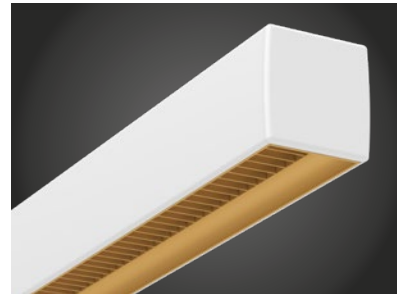

12 White + Gold Matt*

Other RAL colors on request

* Color 12 & 16 UGR values will raise when using gold painted grids.

LEDliner70 Opal

Color possibilities



01 White Matt Texture
Standard

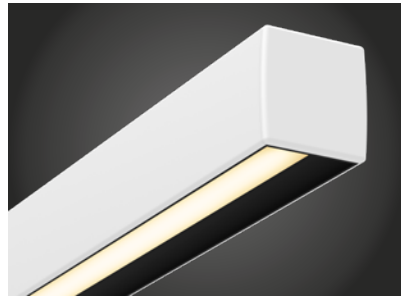

05 White + Black Matt Texture
Standard



18 Grey Matt Texture
Standard

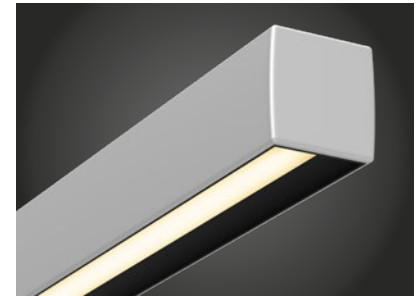

28 Grey + Black Matt Texture
Standard

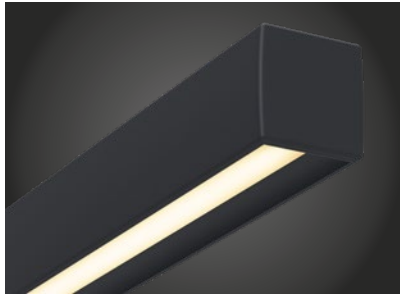

07 Anthracite Matt Texture
Standard



03 Black Matt Texture
Standard

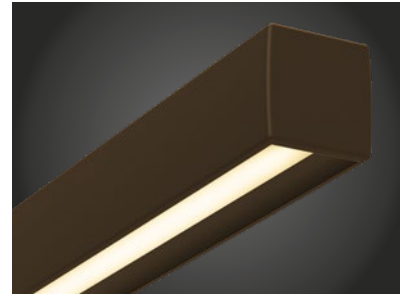

25 Smoked Brown Matt Texture
Standard

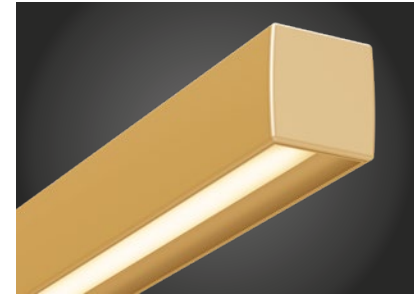

16 Gold Matt

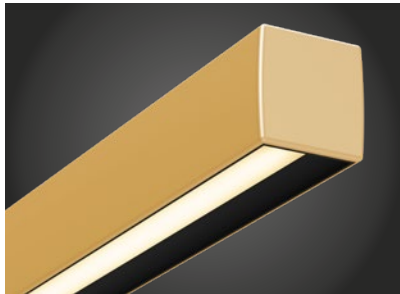

32 Gold + Black Matt T2

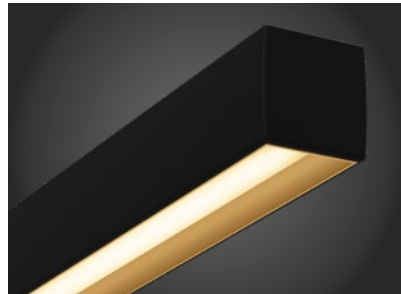

11 Black + Gold Matt

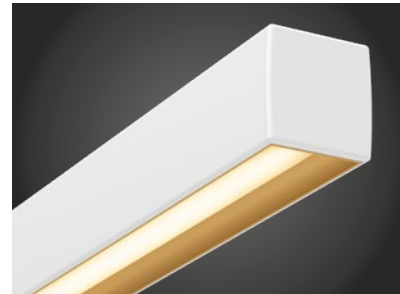

12 White + Gold Matt

Other RAL colors on request

Invisible suspension (internal)



Optional invisible suspension available (on request)

Invisible suspension

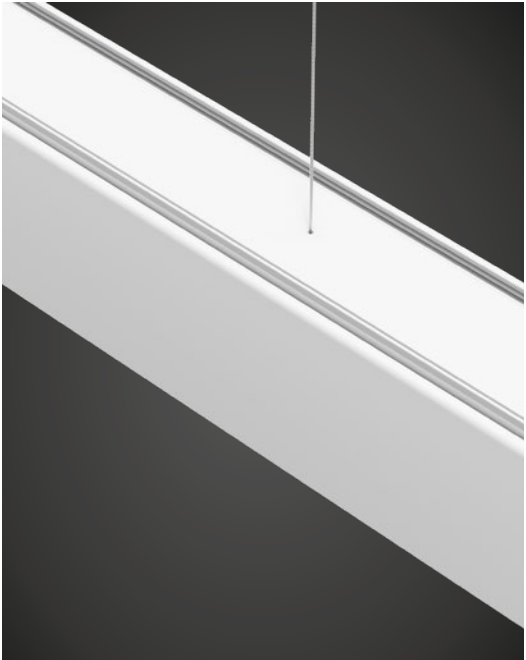

Standard suspension (bracket)

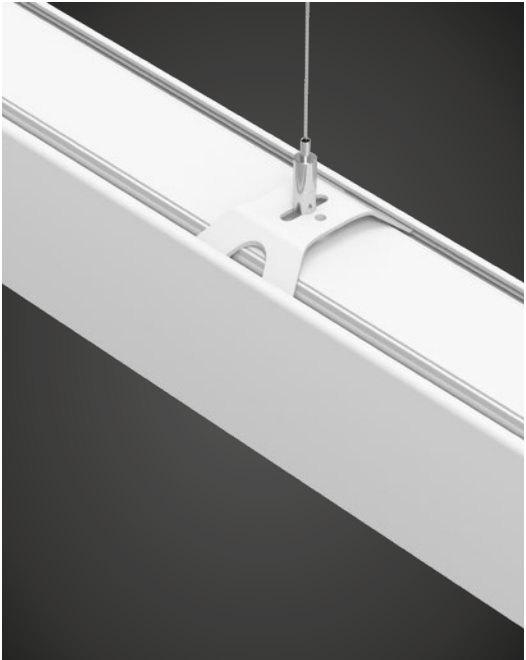

Standard included for suspended Ready-to-go profiles



Ready To Go LEDliner70

UGR<19
Down - Suspended

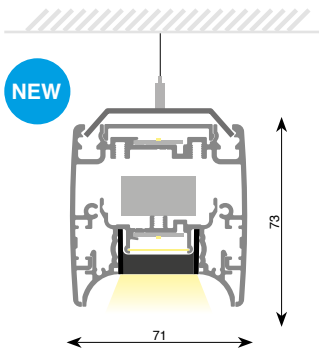

Average weight of equipped profile: 4.3 kg/m

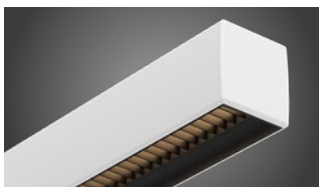

Included

- Profile
- End Caps
- LED Modules
- UGR Grid Down
- Standard Suspension (2000mm)
- Connecting box
- Textile power cable (2000mm)



Article number	Total length	Connected profile lengths excl. end caps	LED Flux* 927	LED Flux* 830 & 930	LED Flux* 840 & 940	LED Flux* Tunable White 2700-6500K	Power** 830 & 840	Power** 927, 930 & 940
R70SU.DM.CCC.xx-05.G	740 mm	-	n.a.***	3120lm	3300lm	n.a.***	15.0W	15.5W
R70SU.DM.CCC.xx-06.G	879 mm	-	3015lm	3120lm	3300lm	3300lm	18.0W	18.6W
R70SU.DM.CCC.xx-07.G	1021 mm	-	n.a.***	3640lm	3850lm	n.a.***	21.0W	21.7W
R70SU.DM.CCC.xx-08.G	1159 mm	-	4020lm	4160lm	4400lm	4400lm	24.0W	24.8W
R70SU.DM.CCC.xx-09.G	1301 mm	-	n.a.***	4680lm	4950lm	n.a.***	27.0W	27.9W
R70SU.DM.CCC.xx-10.G	1441 mm	-	5025lm	5200lm	5500lm	5500lm	30.0W	31.0W
R70SU.DM.CCC.xx-11.G	1583 mm	-	n.a.***	5720lm	6050lm	n.a.***	33.0W	34.1W
R70SU.DM.CCC.xx-12.G	1721 mm	-	6030lm	6240lm	6600lm	6600lm	36.0W	37.2W
R70SU.DM.CCC.xx-13.G	1863 mm	-	n.a.***	6760lm	7150lm	n.a.***	39.0W	40.3W
R70SU.DM.CCC.xx-14.G	2002 mm	-	7035lm	7280lm	7700lm	7700lm	42.0W	43.4W
R70SU.DM.CCC.xx-15.G	2144 mm	-	n.a.***	7800lm	8250lm	n.a.***	45.0W	46.5W
R70SU.DM.CCC.xx-16.G	2282 mm	-	8040lm	8320lm	8800lm	8800lm	48.0W	49.6W
R70SU.DM.CCC.xx-17.G	2424 mm	-	n.a.***	8840lm	9350lm	n.a.***	51.0W	52.7W
R70SU.DM.CCC.xx-18.G	2564 mm	-	9045lm	9360lm	9900lm	9900lm	54.0W	55.8W
R70SU.DM.CCC.xx-19.G	2706 mm	-	n.a.***	9880lm	10450lm	n.a.***	57.0W	58.9W
R70SU.DM.CCC.xx-20.G	2844 mm	-	10050lm	10400lm	11000lm	11000lm	60.0W	62.0W
R70SU.DM.CCC.xx-21.G	2986 mm	-	n.a.***	10920lm	11550lm	n.a.***	63.0W	65.1W
R70SU.DM.CCC.xx-22.G	3125 mm	-	11055lm	11440lm	12100lm	12100lm	66.0W	68.2W
R70SU.DM.CCC.xx-23.G	3267 mm	-	n.a.***	11960lm	12650lm	n.a.***	69.0W	71.3W
R70SU.DM.CCC.xx-24.G	3405 mm	-	12060lm	12480lm	13200lm	13200lm	72.0W	74.4W
R70SU.DM.CCC.xx-25.G	3548 mm	1701+1843 mm	n.a.***	13000lm	13750lm	n.a.***	75.0W	77.5W
R70SU.DM.CCC.xx-26.G	3687 mm	1701+1982 mm	13065lm	13520lm	14300lm	14300lm	78.0W	80.6W
R70SU.DM.CCC.xx-27.G	3829 mm	1843+1982 mm	n.a.***	14040lm	14850lm	n.a.***	81.0W	83.7W
R70SU.DM.CCC.xx-28.G	3968 mm	1982+1982 mm	14070lm	14560lm	15400lm	15400lm	84.0W	86.8W
R70SU.DM.CCC.xx-29.G	4110 mm	1982+2125 mm	n.a.***	15080lm	15950lm	n.a.***	87.0W	89.9W
R70SU.DM.CCC.xx-30.G	4248 mm	1982+2262 mm	15075lm	15600lm	16500lm	16500lm	90.0W	93.0W
R70SU.DM.CCC.xx-31.G	4390 mm	2125+2262 mm	n.a.***	16120lm	17050lm	n.a.***	93.0W	96.1W
R70SU.DM.CCC.xx-32.G	4528 mm	2262+2262 mm	16080lm	16640lm	17600lm	17600lm	96.0W	99.2W
R70SU.DM.CCC.xx-33.G	4670 mm	2262+2405 mm	n.a.***	17160lm	18150lm	n.a.***	99.0W	102.3W
R70SU.DM.CCC.xx-34.G	4810 mm	2262+2544 mm	17085lm	17680lm	18700lm	18700lm	102.0W	105.4W
R70SU.DM.CCC.xx-35.G	4952 mm	2405+2544 mm	n.a.***	18200lm	19250lm	n.a.***	105.0W	108.5W
R70SU.DM.CCC.xx-36.G	5091 mm	2544+2544 mm	18090lm	18720lm	19800lm	19800lm	108.0W	111.6W
R70SU.DM.CCC.xx-37.G	5233 mm	2544+2686 mm	n.a.***	19240lm	20350lm	n.a.***	111.0W	114.7W
R70SU.DM.CCC.xx-38.G	5371 mm	2544+2824 mm	19095lm	19760lm	20900lm	20900lm	114.0W	117.8W
R70SU.DM.CCC.xx-39.G	5513 mm	2544+2966 mm	n.a.***	20280lm	21450lm	n.a.***	117.0W	120.9W
R70SU.DM.CCC.xx-40.G	5653 mm	2544+3105 mm	20100lm	20800lm	22000lm	22000lm	120.0W	124.0W
R70SU.DM.CCC.xx-41.G	5795 mm	2544+3248 mm	n.a.***	21320lm	22550lm	n.a.***	123.0W	127.1W
R70SU.DM.CCC.xx-42.G	5933 mm	2824+3105 mm	21105lm	21840lm	23100lm	23100lm	126.0W	130.2W
R70SU.DM.CCC.xx-43.G	6075 mm	2966+3105 mm	n.a.***	22360lm	23650lm	n.a.***	129.0W	133.3W
R70SU.DM.CCC.xx-44.G	6214 mm	3105+3105 mm	22110lm	22880lm	24200lm	24200lm	132.0W	136.4W
R70SU.DM.CCC.xx-45.G	6356 mm	3105+3248 mm	n.a.***	23400lm	24750lm	n.a.***	135.0W	139.5W
R70SU.DM.CCC.xx-46.G	6494 mm	3105+3385 mm	23115lm	23920lm	25300lm	25300lm	138.0W	142.6W
R70SU.DM.CCC.xx-47.G	6636 mm	3248+3385 mm	n.a.***	24440lm	25850lm	n.a.***	141.0W	145.7W
R70SU.DM.CCC.xx-48.G	6774 mm	3385+3385 mm	24120lm	24960lm	26400lm	26400lm	144.0W	148.8W

* Luminous flux mentioned is the flux of the LED modules. To know the luminous flux of the luminaire, please apply the light output ratios on page 337 or check www.doxis.be.

** Power mentioned is for LED module excl. driver. For Tunable White power consumption please check www.doxis.be. For more detailed information, please check www.doxis.be.

*** Not available. Our supplier, Philips, does not provide 140mm LED modules in 2700K and Tunable White.

Article number structure: **R70SU.DM.CCC.xx-00**

- 24:** Non dimmable
- 25:** 1-10V dimmable
- 26:** Touch & DALI dim
- 830:** Ra80 - 3000K
- 840:** Ra80 - 4000K
- 927:** Ra90 - 2700K
- 930:** Ra90 - 3000K
- 940:** Ra90 - 4000K
- TW:** Tunable white 2700K-6500K
- 01:** White Matt Texture
- 03:** Black Matt Texture
- 05:** White + Black Text.
- 18:** Grey 9006 Matt Text.
- 28:** Grey + Black Matt Text.
- 07:** Anthracite Matt Text.
- 25:** Smoked Brown Matt Text.
- 16:** Gold incl. gold grid
- 11:** Black + Gold
- 32:** Gold + Black
- 12:** White + Gold incl gold grid
- Other colors on request (see page 333)

927 & TW available in limited lengths

Ready To Go LEDliner70 Opal Cover Down - Suspended

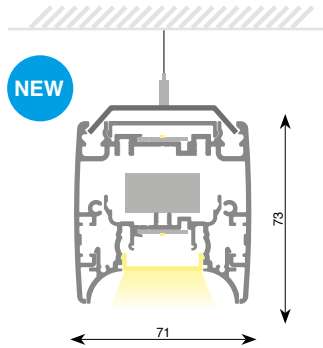

Average weight of equipped profile: 4.3 kg/m

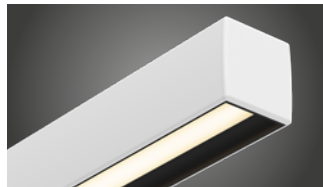

Included

- Profile
- End Caps
- LED Modules
- PC Cover Down
- Standard Suspension (2000mm)
- Connecting box
- Textile power cable (2000mm)



Article number	Total length	Connected profile lengths excl. end caps	LED Flux* 927	LED Flux* 830 & 930	LED Flux* 840 & 940	LED Flux* Tunable White 2700-6500K	Power** 830 & 840	Power** 927, 930 & 940
R70SU.DM.CCC.xx-05	740 mm	-	n.a.***	3120lm	3300lm	n.a.***	15.0W	15.5W
R70SU.DM.CCC.xx-06	879 mm	-	3015lm	3120lm	3300lm	3300lm	18.0W	18.6W
R70SU.DM.CCC.xx-07	1021 mm	-	n.a.***	3640lm	3850lm	n.a.***	21.0W	21.7W
R70SU.DM.CCC.xx-08	1159 mm	-	4020lm	4160lm	4400lm	4400lm	24.0W	24.8W
R70SU.DM.CCC.xx-09	1301 mm	-	n.a.***	4680lm	4950lm	n.a.***	27.0W	27.9W
R70SU.DM.CCC.xx-10	1441 mm	-	5025lm	5200lm	5500lm	5500lm	30.0W	31.0W
R70SU.DM.CCC.xx-11	1583 mm	-	n.a.***	5720lm	6050lm	n.a.***	33.0W	34.1W
R70SU.DM.CCC.xx-12	1721 mm	-	6030lm	6240lm	6600lm	6600lm	36.0W	37.2W
R70SU.DM.CCC.xx-13	1863 mm	-	n.a.***	6760lm	7150lm	n.a.***	39.0W	40.3W
R70SU.DM.CCC.xx-14	2002 mm	-	7035lm	7280lm	7700lm	7700lm	42.0W	43.4W
R70SU.DM.CCC.xx-15	2144 mm	-	n.a.***	7800lm	8250lm	n.a.***	45.0W	46.5W
R70SU.DM.CCC.xx-16	2282 mm	-	8040lm	8320lm	8800lm	8800lm	48.0W	49.6W
R70SU.DM.CCC.xx-17	2424 mm	-	n.a.***	8840lm	9350lm	n.a.***	51.0W	52.7W
R70SU.DM.CCC.xx-18	2564 mm	-	9045lm	9360lm	9900lm	9900lm	54.0W	55.8W
R70SU.DM.CCC.xx-19	2706 mm	-	n.a.***	9880lm	10450lm	n.a.***	57.0W	58.9W
R70SU.DM.CCC.xx-20	2844 mm	-	10050lm	10400lm	11000lm	11000lm	60.0W	62.0W
R70SU.DM.CCC.xx-21	2986 mm	-	n.a.***	10920lm	11550lm	n.a.***	63.0W	65.1W
R70SU.DM.CCC.xx-22	3125 mm	-	11055lm	11440lm	12100lm	12100lm	66.0W	68.2W
R70SU.DM.CCC.xx-23	3267 mm	-	n.a.***	11960lm	12650lm	n.a.***	69.0W	71.3W
R70SU.DM.CCC.xx-24	3405 mm	-	12060lm	12480lm	13200lm	13200lm	72.0W	74.4W
R70SU.DM.CCC.xx-25	3548 mm	1701+1843 mm	n.a.***	13000lm	13750lm	n.a.***	75.0W	77.5W
R70SU.DM.CCC.xx-26	3687 mm	1701+1982 mm	13065lm	13520lm	14300lm	14300lm	78.0W	80.6W
R70SU.DM.CCC.xx-27	3829 mm	1843+1982 mm	n.a.***	14040lm	14850lm	n.a.***	81.0W	83.7W
R70SU.DM.CCC.xx-28	3968 mm	1982+1982 mm	14070lm	14560lm	15400lm	15400lm	84.0W	86.8W
R70SU.DM.CCC.xx-29	4110 mm	1982+2125 mm	n.a.***	15080lm	15950lm	n.a.***	87.0W	89.9W
R70SU.DM.CCC.xx-30	4248 mm	1982+2262 mm	15075lm	15600lm	16500lm	16500lm	90.0W	93.0W
R70SU.DM.CCC.xx-31	4390 mm	2125+2262 mm	n.a.***	16120lm	17050lm	n.a.***	93.0W	96.1W
R70SU.DM.CCC.xx-32	4528 mm	2262+2262 mm	16080lm	16640lm	17600lm	17600lm	96.0W	99.2W
R70SU.DM.CCC.xx-33	4670 mm	2262+2405 mm	n.a.***	17160lm	18150lm	n.a.***	99.0W	102.3W
R70SU.DM.CCC.xx-34	4810 mm	2262+2544 mm	17085lm	17680lm	18700lm	18700lm	102.0W	105.4W
R70SU.DM.CCC.xx-35	4952 mm	2405+2544 mm	n.a.***	18200lm	19250lm	n.a.***	105.0W	108.5W
R70SU.DM.CCC.xx-36	5091 mm	2544+2544 mm	18090lm	18720lm	19800lm	19800lm	108.0W	111.6W
R70SU.DM.CCC.xx-37	5233 mm	2544+2686 mm	n.a.***	19240lm	20350lm	n.a.***	111.0W	114.7W
R70SU.DM.CCC.xx-38	5371 mm	2544+2824 mm	19095lm	19760lm	20900lm	20900lm	114.0W	117.8W
R70SU.DM.CCC.xx-39	5513 mm	2544+2966 mm	n.a.***	20280lm	21450lm	n.a.***	117.0W	120.9W
R70SU.DM.CCC.xx-40	5653 mm	2544+3105 mm	20100lm	20800lm	22000lm	22000lm	120.0W	124.0W
R70SU.DM.CCC.xx-41	5795 mm	2544+3248 mm	n.a.***	21320lm	22550lm	n.a.***	123.0W	127.1W
R70SU.DM.CCC.xx-42	5933 mm	2824+3105 mm	21105lm	21840lm	23100lm	23100lm	126.0W	130.2W
R70SU.DM.CCC.xx-43	6075 mm	2966+3105 mm	n.a.***	22360lm	23650lm	n.a.***	129.0W	133.3W
R70SU.DM.CCC.xx-44	6214 mm	3105+3105 mm	22110lm	22880lm	24200lm	24200lm	132.0W	136.4W
R70SU.DM.CCC.xx-45	6356 mm	3105+3248 mm	n.a.***	23400lm	24750lm	n.a.***	135.0W	139.5W
R70SU.DM.CCC.xx-46	6494 mm	3105+3385 mm	23115lm	23920lm	25300lm	25300lm	138.0W	142.6W
R70SU.DM.CCC.xx-47	6636 mm	3248+3385 mm	n.a.***	24440lm	25850lm	n.a.***	141.0W	145.7W
R70SU.DM.CCC.xx-48	6774 mm	3385+3385 mm	24120lm	24960lm	26400lm	26400lm	144.0W	148.8W

* Luminous flux mentioned is the flux of the LED modules. To know the luminous flux of the luminaire, please apply the light output ratios on page 337 or check www.doxis.be.

** Power mentioned is for LED module excl. driver. For Tunable White power consumption please check www.doxis.be. For more detailed information, please check www.doxis.be

*** Not available. Our supplier, Philips, does not provide 140mm LED modules in 2700K and Tunable White.

Article number structure: **R70SU.DM.CCC.xx-00**

- 24:** Non dimmable
- 25:** 1-10V dimmable
- 26:** Touch & DALI dim

- 830:** Ra80 - 3000K
 - 840:** Ra80 - 4000K
 - 927:** Ra90 - 2700K
 - 930:** Ra90 - 3000K
 - 940:** Ra90 - 4000K
 - TW:** Tunable white 2700K-6500K
- 927 & TW available in limited lengths

- 01:** White Matt Texture
- 03:** Black Matt Texture
- 05:** White + Black Text.
- 18:** Grey 9006 Matt Text.
- 28:** Grey + Black Matt Text.
- 07:** Anthracite Matt Text.
- 25:** Smoked Brown Matt Text.

- 16:** Gold incl. gold grid
 - 11:** Black + Gold
 - 32:** Gold + Black
 - 12:** White + Gold incl gold grid
- Other colors on request (see page 333)

Ready To Go LEDliner70

UGR<19
Down - Ceiling Mounted

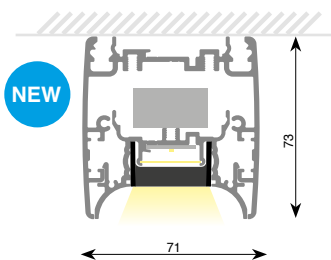

Average weight of equipped profile: 4.3 kg/m

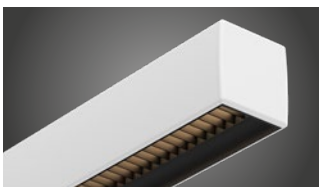

Included

- Profile
- End Caps
- LED Modules
- UGR Grid Down

Article number	Total length	Connected profile lengths excl. end caps	LED Flux* 927	LED Flux* 830 & 930	LED Flux* 840 & 940	LED Flux* Tunable White 2700-6500K	Power** 830 & 840	Power** 927, 930 & 940
R70CM.DM.CCC.xx-05.G	740 mm	-	n.a.***	3120lm	3300lm	n.a.***	15.0W	15.5W
R70CM.DM.CCC.xx-06.G	879 mm	-	3015lm	3120lm	3300lm	3300lm	18.0W	18.6W
R70CM.DM.CCC.xx-07.G	1021 mm	-	n.a.***	3640lm	3850lm	n.a.***	21.0W	21.7W
R70CM.DM.CCC.xx-08.G	1159 mm	-	4020lm	4160lm	4400lm	4400lm	24.0W	24.8W
R70CM.DM.CCC.xx-09.G	1301 mm	-	n.a.***	4680lm	4950lm	n.a.***	27.0W	27.9W
R70CM.DM.CCC.xx-10.G	1441 mm	-	5025lm	5200lm	5500lm	5500lm	30.0W	31.0W
R70CM.DM.CCC.xx-11.G	1583 mm	-	n.a.***	5720lm	6050lm	n.a.***	33.0W	34.1W
R70CM.DM.CCC.xx-12.G	1721 mm	-	6030lm	6240lm	6600lm	6600lm	36.0W	37.2W
R70CM.DM.CCC.xx-13.G	1863 mm	-	n.a.***	6760lm	7150lm	n.a.***	39.0W	40.3W
R70CM.DM.CCC.xx-14.G	2002 mm	-	7035lm	7280lm	7700lm	7700lm	42.0W	43.4W
R70CM.DM.CCC.xx-15.G	2144 mm	-	n.a.***	7800lm	8250lm	n.a.***	45.0W	46.5W
R70CM.DM.CCC.xx-16.G	2282 mm	-	8040lm	8320lm	8800lm	8800lm	48.0W	49.6W
R70CM.DM.CCC.xx-17.G	2424 mm	-	n.a.***	8840lm	9350lm	n.a.***	51.0W	52.7W
R70CM.DM.CCC.xx-18.G	2564 mm	-	9045lm	9360lm	9900lm	9900lm	54.0W	55.8W
R70CM.DM.CCC.xx-19.G	2706 mm	-	n.a.***	9880lm	10450lm	n.a.***	57.0W	58.9W
R70CM.DM.CCC.xx-20.G	2844 mm	-	10050lm	10400lm	11000lm	11000lm	60.0W	62.0W
R70CM.DM.CCC.xx-21.G	2986 mm	-	n.a.***	10920lm	11550lm	n.a.***	63.0W	65.1W
R70CM.DM.CCC.xx-22.G	3125 mm	-	11055lm	11440lm	12100lm	12100lm	66.0W	68.2W
R70CM.DM.CCC.xx-23.G	3267 mm	-	n.a.***	11960lm	12650lm	n.a.***	69.0W	71.3W
R70CM.DM.CCC.xx-24.G	3405 mm	-	12060lm	12480lm	13200lm	13200lm	72.0W	74.4W
R70CM.DM.CCC.xx-25.G	3548 mm	1701+1843 mm	n.a.***	13000lm	13750lm	n.a.***	75.0W	77.5W
R70CM.DM.CCC.xx-26.G	3687 mm	1701+1982 mm	13065lm	13520lm	14300lm	14300lm	78.0W	80.6W
R70CM.DM.CCC.xx-27.G	3829 mm	1843+1982 mm	n.a.***	14040lm	14850lm	n.a.***	81.0W	83.7W
R70CM.DM.CCC.xx-28.G	3968 mm	1982+1982 mm	14070lm	14560lm	15400lm	15400lm	84.0W	86.8W
R70CM.DM.CCC.xx-29.G	4110 mm	1982+2125 mm	n.a.***	15080lm	15950lm	n.a.***	87.0W	89.9W
R70CM.DM.CCC.xx-30.G	4248 mm	1982+2262 mm	15075lm	15600lm	16500lm	16500lm	90.0W	93.0W
R70CM.DM.CCC.xx-31.G	4390 mm	2125+2262 mm	n.a.***	16120lm	17050lm	n.a.***	93.0W	96.1W
R70CM.DM.CCC.xx-32.G	4528 mm	2262+2262 mm	16080lm	16640lm	17600lm	17600lm	96.0W	99.2W
R70CM.DM.CCC.xx-33.G	4670 mm	2262+2405 mm	n.a.***	17160lm	18150lm	n.a.***	99.0W	102.3W
R70CM.DM.CCC.xx-34.G	4810 mm	2262+2544 mm	17085lm	17680lm	18700lm	18700lm	102.0W	105.4W
R70CM.DM.CCC.xx-35.G	4952 mm	2405+2544 mm	n.a.***	18200lm	19250lm	n.a.***	105.0W	108.5W
R70CM.DM.CCC.xx-36.G	5091 mm	2544+2544 mm	18090lm	18720lm	19800lm	19800lm	108.0W	111.6W
R70CM.DM.CCC.xx-37.G	5233 mm	2544+2686 mm	n.a.***	19240lm	20350lm	n.a.***	111.0W	114.7W
R70CM.DM.CCC.xx-38.G	5371 mm	2544+2824 mm	19095lm	19760lm	20900lm	20900lm	114.0W	117.8W
R70CM.DM.CCC.xx-39.G	5513 mm	2544+2966 mm	n.a.***	20280lm	21450lm	n.a.***	117.0W	120.9W
R70CM.DM.CCC.xx-40.G	5653 mm	2544+3105 mm	20100lm	20800lm	22000lm	22000lm	120.0W	124.0W
R70CM.DM.CCC.xx-41.G	5795 mm	2544+3248 mm	n.a.***	21320lm	22550lm	n.a.***	123.0W	127.1W
R70CM.DM.CCC.xx-42.G	5933 mm	2824+3105 mm	21105lm	21840lm	23100lm	23100lm	126.0W	130.2W
R70CM.DM.CCC.xx-43.G	6075 mm	2966+3105 mm	n.a.***	22360lm	23650lm	n.a.***	129.0W	133.3W
R70CM.DM.CCC.xx-44.G	6214 mm	3105+3105 mm	22110lm	22880lm	24200lm	24200lm	132.0W	136.4W
R70CM.DM.CCC.xx-45.G	6356 mm	3105+3248 mm	n.a.***	23400lm	24750lm	n.a.***	135.0W	139.5W
R70CM.DM.CCC.xx-46.G	6494 mm	3105+3385 mm	23115lm	23920lm	25300lm	25300lm	138.0W	142.6W
R70CM.DM.CCC.xx-47.G	6636 mm	3248+3385 mm	n.a.***	24440lm	25850lm	n.a.***	141.0W	145.7W
R70CM.DM.CCC.xx-48.G	6774 mm	3385+3385 mm	24120lm	24960lm	26400lm	26400lm	144.0W	148.8W

* Luminous flux mentioned is the flux of the LED modules. To know the luminous flux of the luminaire, please apply the light output ratios on page 337 or check www.doxis.be.

** Power mentioned is for LED module excl. driver. For Tunable White power consumption please check www.doxis.be. For more detailed information, please check www.doxis.be

*** Not available. Our supplier, Philips, does not provide 140mm LED modules in 2700K and Tunable White.

Article number structure: **R70CM.DM.CCC.xx-00**

- 24:** Non dimmable
- 25:** 1-10V dimmable
- 26:** Touch & DALI dim
- 830:** Ra80 - 3000K
- 840:** Ra80 - 4000K
- 927:** Ra90 - 2700K
- 930:** Ra90 - 3000K
- 940:** Ra90 - 4000K
- TW:** Tunable white 2700K-6500K
927 & TW available in limited lengths
- 01:** White Matt Texture
- 03:** Black Matt Texture
- 05:** White + Black Text.
- 18:** Grey 9006 Matt Text.
- 28:** Grey + Black Matt Text.
- 07:** Anthracite Matt Text.
- 25:** Smoked Brown Matt Text.
- 16:** Gold incl. gold grid
- 11:** Black + Gold
- 32:** Gold + Black
- 12:** White + Gold incl gold grid
- Other colors on request (see page 333)

Ready To Go LEDliner70

Opal Cover Down - Ceiling Mounted

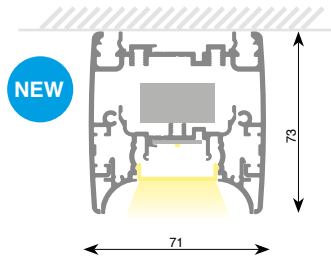

Average weight of equipped profile: 4.3 kg/m

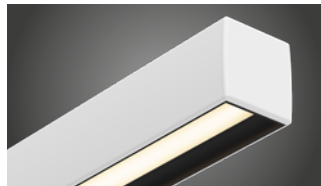

Included

- Profile
- End Caps
- LED Modules
- PC Covers Down

Article number	Total length	Connected profile lengths excl. end caps	LED Flux* 927	LED Flux* 830 & 930	LED Flux* 840 & 940	LED Flux* Tunable White 2700-6500K	Power** 830 & 840	Power** 927, 930 & 940
R70CM.DM.CCC.xx-05	740 mm	-	n.a.***	3120lm	3300lm	n.a.***	15.0W	15.5W
R70CM.DM.CCC.xx-06	879 mm	-	3015lm	3120lm	3300lm	3300lm	18.0W	18.6W
R70CM.DM.CCC.xx-07	1021 mm	-	n.a.***	3640lm	3850lm	n.a.***	21.0W	21.7W
R70CM.DM.CCC.xx-08	1159 mm	-	4020lm	4160lm	4400lm	4400lm	24.0W	24.8W
R70CM.DM.CCC.xx-09	1301 mm	-	n.a.***	4680lm	4950lm	n.a.***	27.0W	27.9W
R70CM.DM.CCC.xx-10	1441 mm	-	5025lm	5200lm	5500lm	5500lm	30.0W	31.0W
R70CM.DM.CCC.xx-11	1583 mm	-	n.a.***	5720lm	6050lm	n.a.***	33.0W	34.1W
R70CM.DM.CCC.xx-12	1721 mm	-	6030lm	6240lm	6600lm	6600lm	36.0W	37.2W
R70CM.DM.CCC.xx-13	1863 mm	-	n.a.***	6760lm	7150lm	n.a.***	39.0W	40.3W
R70CM.DM.CCC.xx-14	2002 mm	-	7035lm	7280lm	7700lm	7700lm	42.0W	43.4W
R70CM.DM.CCC.xx-15	2144 mm	-	n.a.***	7800lm	8250lm	n.a.***	45.0W	46.5W
R70CM.DM.CCC.xx-16	2282 mm	-	8040lm	8320lm	8800lm	8800lm	48.0W	49.6W
R70CM.DM.CCC.xx-17	2424 mm	-	n.a.***	8840lm	9350lm	n.a.***	51.0W	52.7W
R70CM.DM.CCC.xx-18	2564 mm	-	9045lm	9360lm	9900lm	9900lm	54.0W	55.8W
R70CM.DM.CCC.xx-19	2706 mm	-	n.a.***	9880lm	10450lm	n.a.***	57.0W	58.9W
R70CM.DM.CCC.xx-20	2844 mm	-	10050lm	10400lm	11000lm	11000lm	60.0W	62.0W
R70CM.DM.CCC.xx-21	2986 mm	-	n.a.***	10920lm	11550lm	n.a.***	63.0W	65.1W
R70CM.DM.CCC.xx-22	3125 mm	-	11055lm	11440lm	12100lm	12100lm	66.0W	68.2W
R70CM.DM.CCC.xx-23	3267 mm	-	n.a.***	11960lm	12650lm	n.a.***	69.0W	71.3W
R70CM.DM.CCC.xx-24	3405 mm	-	12060lm	12480lm	13200lm	13200lm	72.0W	74.4W
R70CM.DM.CCC.xx-25	3548 mm	1701+1843 mm	n.a.***	13000lm	13750lm	n.a.***	75.0W	77.5W
R70CM.DM.CCC.xx-26	3687 mm	1701+1982 mm	13065lm	13520lm	14300lm	14300lm	78.0W	80.6W
R70CM.DM.CCC.xx-27	3829 mm	1843+1982 mm	n.a.***	14040lm	14850lm	n.a.***	81.0W	83.7W
R70CM.DM.CCC.xx-28	3968 mm	1982+1982 mm	14070lm	14560lm	15400lm	15400lm	84.0W	86.8W
R70CM.DM.CCC.xx-29	4110 mm	1982+2125 mm	n.a.***	15080lm	15950lm	n.a.***	87.0W	89.9W
R70CM.DM.CCC.xx-30	4248 mm	1982+2262 mm	15075lm	15600lm	16500lm	16500lm	90.0W	93.0W
R70CM.DM.CCC.xx-31	4390 mm	2125+2262 mm	n.a.***	16120lm	17050lm	n.a.***	93.0W	96.1W
R70CM.DM.CCC.xx-32	4528 mm	2262+2262 mm	16080lm	16640lm	17600lm	17600lm	96.0W	99.2W
R70CM.DM.CCC.xx-33	4670 mm	2262+2405 mm	n.a.***	17160lm	18150lm	n.a.***	99.0W	102.3W
R70CM.DM.CCC.xx-34	4810 mm	2262+2544 mm	17085lm	17680lm	18700lm	18700lm	102.0W	105.4W
R70CM.DM.CCC.xx-35	4952 mm	2405+2544 mm	n.a.***	18200lm	19250lm	n.a.***	105.0W	108.5W
R70CM.DM.CCC.xx-36	5091 mm	2544+2544 mm	18090lm	18720lm	19800lm	19800lm	108.0W	111.6W
R70CM.DM.CCC.xx-37	5233 mm	2544+2686 mm	n.a.***	19240lm	20350lm	n.a.***	111.0W	114.7W
R70CM.DM.CCC.xx-38	5371 mm	2544+2824 mm	19095lm	19760lm	20900lm	20900lm	114.0W	117.8W
R70CM.DM.CCC.xx-39	5513 mm	2544+2966 mm	n.a.***	20280lm	21450lm	n.a.***	117.0W	120.9W
R70CM.DM.CCC.xx-40	5653 mm	2544+3105 mm	20100lm	20800lm	22000lm	22000lm	120.0W	124.0W
R70CM.DM.CCC.xx-41	5795 mm	2544+3248 mm	n.a.***	21320lm	22550lm	n.a.***	123.0W	127.1W
R70CM.DM.CCC.xx-42	5933 mm	2824+3105 mm	21105lm	21840lm	23100lm	23100lm	126.0W	130.2W
R70CM.DM.CCC.xx-43	6075 mm	2966+3105 mm	n.a.***	22360lm	23650lm	n.a.***	129.0W	133.3W
R70CM.DM.CCC.xx-44	6214 mm	3105+3105 mm	22110lm	22880lm	24200lm	24200lm	132.0W	136.4W
R70CM.DM.CCC.xx-45	6356 mm	3105+3248 mm	n.a.***	23400lm	24750lm	n.a.***	135.0W	139.5W
R70CM.DM.CCC.xx-46	6494 mm	3105+3385 mm	23115lm	23920lm	25300lm	25300lm	138.0W	142.6W
R70CM.DM.CCC.xx-47	6636 mm	3248+3385 mm	n.a.***	24440lm	25850lm	n.a.***	141.0W	145.7W
R70CM.DM.CCC.xx-48	6774 mm	3385+3385 mm	24120lm	24960lm	26400lm	26400lm	144.0W	148.8W

* Luminous flux mentioned is the flux of the LED modules. To know the luminous flux of the luminaire, please apply the light output ratios on page 337 or check www.doxis.be.

** Power mentioned is for LED module excl. driver. For Tunable White power consumption please check www.doxis.be. For more detailed information, please check www.doxis.be

*** Not available. Our supplier, Philips, does not provide 140mm LED modules in 2700K and Tunable White.

Article number structure: **R70CM.DM.CCC.xx-00**

- 24:** Non dimmable
- 25:** 1-10V dimmable
- 26:** Touch & DALI dim

- 830:** Ra80 - 3000K
 - 840:** Ra80 - 4000K
 - 927:** Ra90 - 2700K
 - 930:** Ra90 - 3000K
 - 940:** Ra90 - 4000K
 - TW:** Tunable white 2700K-6500K
- 927 & TW available in limited lengths

- 01:** White Matt Texture
- 03:** Black Matt Texture
- 05:** White + Black Text.
- 18:** Grey 9006 Matt Text.
- 28:** Grey + Black Matt Text.
- 07:** Anthracite Matt Text.
- 25:** Smoked Brown Matt Text.

- 16:** Gold incl. gold grid
 - 11:** Black + Gold
 - 32:** Gold + Black
 - 12:** White + Gold incl gold grid
- Other colors on request (see page 333)

Ready To Go LEDliner70

UGR<19

Up&Down - Suspended
Single Circuit

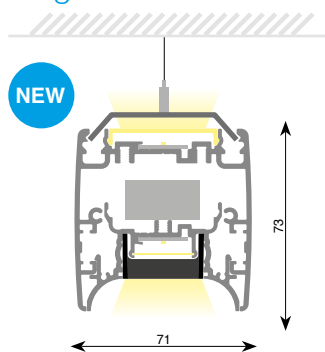

Average weight of equipped profile: 4.3 kg/m

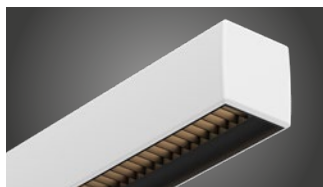

Included

- Profile
- End Caps
- LED Modules
- UGR Grid Down
- Opal cover up
- Standard Suspension (2000mm)
- Connecting box
- Textile power cable (2000mm)



Article number	Total length	Connected profile lengths excl. end caps	LED Flux* 927	LED Flux* 830 & 930	LED Flux* 840 & 940	LED Flux* Tunable White 2700-6500K	Power** 830 & 840	Power** 927, 930 & 940
R70S1.DM.CCC.xx-05.G	740 mm	-	n.a.***	2x3120lm	2x3300lm	n.a.***	2x15.0W	2x15.5W
R70S1.DM.CCC.xx-06.G	879 mm	-	2x3015lm	2x3120lm	2x3300lm	2x3300lm	2x18.0W	2x18.6W
R70S1.DM.CCC.xx-07.G	1021 mm	-	n.a.***	2x3640lm	2x3850lm	n.a.***	2x21.0W	2x21.7W
R70S1.DM.CCC.xx-08.G	1159 mm	-	2x4020lm	2x4160lm	2x4400lm	2x4400lm	2x24.0W	2x24.8W
R70S1.DM.CCC.xx-09.G	1301 mm	-	n.a.***	2x4680lm	2x4950lm	n.a.***	2x27.0W	2x27.9W
R70S1.DM.CCC.xx-10.G	1441 mm	-	2x5025lm	2x5200lm	2x5500lm	2x5500lm	2x30.0W	2x31.0W
R70S1.DM.CCC.xx-11.G	1583 mm	-	n.a.***	2x5720lm	2x6050lm	n.a.***	2x33.0W	2x34.1W
R70S1.DM.CCC.xx-12.G	1721 mm	-	2x6030lm	2x6240lm	2x6600lm	2x6600lm	2x36.0W	2x37.2W
R70S1.DM.CCC.xx-13.G	1863 mm	-	n.a.***	2x6760lm	2x7150lm	n.a.***	2x39.0W	2x40.3W
R70S1.DM.CCC.xx-14.G	2002 mm	-	2x7035lm	2x7280lm	2x7700lm	2x7700lm	2x42.0W	2x43.4W
R70S1.DM.CCC.xx-15.G	2144 mm	-	n.a.***	2x7800lm	2x8250lm	n.a.***	2x45.0W	2x46.5W
R70S1.DM.CCC.xx-16.G	2282 mm	-	2x8040lm	2x8320lm	2x8800lm	2x8800lm	2x48.0W	2x49.6W
R70S1.DM.CCC.xx-17.G	2424 mm	-	n.a.***	2x8840lm	2x9350lm	n.a.***	2x51.0W	2x52.7W
R70S1.DM.CCC.xx-18.G	2564 mm	-	2x9045lm	2x9360lm	2x9900lm	2x9900lm	2x54.0W	2x55.8W
R70S1.DM.CCC.xx-19.G	2706 mm	-	n.a.***	2x9880lm	2x10450lm	n.a.***	2x57.0W	2x58.9W
R70S1.DM.CCC.xx-20.G	2844 mm	-	2x10050lm	2x10400lm	2x11000lm	2x11000lm	2x60.0W	2x62.0W
R70S1.DM.CCC.xx-21.G	2986 mm	-	n.a.***	2x10920lm	2x11550lm	n.a.***	2x63.0W	2x65.1W
R70S1.DM.CCC.xx-22.G	3125 mm	-	2x11055lm	2x11440lm	2x12100lm	2x12100lm	2x66.0W	2x68.2W
R70S1.DM.CCC.xx-23.G	3267 mm	-	n.a.***	2x11960lm	2x12650lm	n.a.***	2x69.0W	2x71.3W
R70S1.DM.CCC.xx-24.G	3405 mm	-	2x12060lm	2x12480lm	2x13200lm	2x13200lm	2x72.0W	2x74.4W
R70S1.DM.CCC.xx-25.G	3548 mm	1701+1843 mm	n.a.***	2x13000lm	2x13750lm	n.a.***	2x75.0W	2x77.5W
R70S1.DM.CCC.xx-26.G	3687 mm	1701+1982 mm	2x13065lm	2x13520lm	2x14300lm	2x14300lm	2x78.0W	2x80.6W
R70S1.DM.CCC.xx-27.G	3829 mm	1843+1982 mm	n.a.***	2x14040lm	2x14850lm	n.a.***	2x81.0W	2x83.7W
R70S1.DM.CCC.xx-28.G	3968 mm	1982+1982 mm	2x14070lm	2x14560lm	2x15400lm	2x15400lm	2x84.0W	2x86.8W
R70S1.DM.CCC.xx-29.G	4110 mm	1982+2125 mm	n.a.***	2x15080lm	2x15950lm	n.a.***	2x87.0W	2x89.9W
R70S1.DM.CCC.xx-30.G	4248 mm	1982+2262 mm	2x15075lm	2x15600lm	2x16500lm	2x16500lm	2x90.0W	2x93.0W
R70S1.DM.CCC.xx-31.G	4390 mm	2125+2262 mm	n.a.***	2x16120lm	2x17050lm	n.a.***	2x93.0W	2x96.1W
R70S1.DM.CCC.xx-32.G	4528 mm	2262+2262 mm	2x16080lm	2x16640lm	2x17600lm	2x17600lm	2x96.0W	2x99.2W
R70S1.DM.CCC.xx-33.G	4670 mm	2262+2405 mm	n.a.***	2x17160lm	2x18150lm	n.a.***	2x99.0W	2x102.3W
R70S1.DM.CCC.xx-34.G	4810 mm	2262+2544 mm	2x17085lm	2x17680lm	2x18700lm	2x18700lm	2x102.0W	2x105.4W
R70S1.DM.CCC.xx-35.G	4952 mm	2405+2544 mm	n.a.***	2x18200lm	2x19250lm	n.a.***	2x105.0W	2x108.5W
R70S1.DM.CCC.xx-36.G	5091 mm	2544+2544 mm	2x18090lm	2x18720lm	2x19800lm	2x19800lm	2x108.0W	2x111.6W
R70S1.DM.CCC.xx-37.G	5233 mm	2544+2686 mm	n.a.***	2x19240lm	2x20350lm	n.a.***	2x111.0W	2x114.7W
R70S1.DM.CCC.xx-38.G	5371 mm	2544+2824 mm	2x19095lm	2x19760lm	2x20900lm	2x20900lm	2x114.0W	2x117.8W
R70S1.DM.CCC.xx-39.G	5513 mm	2544+2966 mm	n.a.***	2x20280lm	2x21450lm	n.a.***	2x117.0W	2x120.9W
R70S1.DM.CCC.xx-40.G	5653 mm	2544+3105 mm	2x20100lm	2x20800lm	2x22000lm	2x22000lm	2x120.0W	2x124.0W
R70S1.DM.CCC.xx-41.G	5795 mm	2544+3248 mm	n.a.***	2x21320lm	2x22550lm	n.a.***	2x123.0W	2x127.1W
R70S1.DM.CCC.xx-42.G	5933 mm	2824+3105 mm	2x21105lm	2x21840lm	2x23100lm	2x23100lm	2x126.0W	2x130.2W
R70S1.DM.CCC.xx-43.G	6075 mm	2966+3105 mm	n.a.***	2x22360lm	2x23650lm	n.a.***	2x129.0W	2x133.3W
R70S1.DM.CCC.xx-44.G	6214 mm	3105+3105 mm	2x22110lm	2x22880lm	2x24200lm	2x24200lm	2x132.0W	2x136.4W
R70S1.DM.CCC.xx-45.G	6356 mm	3105+3248 mm	n.a.***	2x23400lm	2x24750lm	n.a.***	2x135.0W	2x139.5W
R70S1.DM.CCC.xx-46.G	6494 mm	3105+3385 mm	2x23115lm	2x23920lm	2x25300lm	2x25300lm	2x138.0W	2x142.6W
R70S1.DM.CCC.xx-47.G	6636 mm	3248+3385 mm	n.a.***	2x24440lm	2x25850lm	n.a.***	2x141.0W	2x145.7W
R70S1.DM.CCC.xx-48.G	6774 mm	3385+3385 mm	2x24120lm	2x24960lm	2x26400lm	2x26400lm	2x144.0W	2x148.8W

* Luminous flux mentioned is the flux of the LED modules. To know the luminous flux of the luminaire, please apply the light output ratios on page 337 or check www.doxis.be.

** Power mentioned is for LED module excl. driver. For Tunable White power consumption please check www.doxis.be. For more detailed information, please check www.doxis.be

*** Not available. Our supplier, Philips, does not provide 140mm LED modules in 2700K and Tunable White.

Article number structure: **R70S1.DM.CCC.xx-00**

- 24: Non dimmable
- 830: Ra80 - 3000K
- 01: White Matt Texture
- 25: 1-10V dimmable
- 840: Ra80 - 4000K
- 03: Black Matt Texture
- 26: Touch & DALI dim
- 927: Ra90 - 2700K
- 05: White + Black Text.
- 930: Ra90 - 3000K
- 18: Grey 9006 Matt Text.
- 940: Ra90 - 4000K
- 28: Grey + Black Matt Text.
- TW: Tunable white 2700K-6500K
- 07: Anthracite Matt Text.
- 927 & TW available in limited lengths
- 25: Smoked Brown Matt Text.
- 12: White + Gold incl gold grid
- 11: Black + Gold
- 32: Gold + Black
- Other colors on request (see page 333)

Ready To Go LEDliner70

Opal Cover
Up&Down - Suspended
Single Circuit

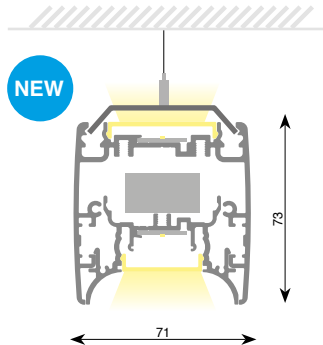

Average weight of equipped profile: 4.3 kg/m

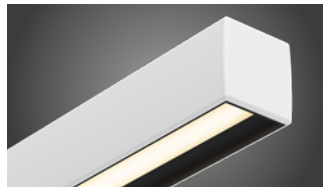

Included

- Profile
- End Caps
- LED Modules
- PC cover down
- Opal cover up
- Standard Suspension (2000mm)
- Connecting box
- Textile power cable (2000mm)



Article number	Total length	Connected profile lengths excl. end caps	LED Flux* 927	LED Flux* 830 & 930	LED Flux* 840 & 940	LED Flux* Tunable White 2700-6500K	Power** 830 & 840	Power** 927, 930 & 940
R70S1.DM.CCC.xx-05	740 mm	-	n.a.***	2x3120lm	2x3300lm	n.a.***	2x15.0W	2x15.5W
R70S1.DM.CCC.xx-06	879 mm	-	2x3015lm	2x3120lm	2x3300lm	2x3300lm	2x18.0W	2x18.6W
R70S1.DM.CCC.xx-07	1021 mm	-	n.a.***	2x3640lm	2x3850lm	n.a.***	2x21.0W	2x21.7W
R70S1.DM.CCC.xx-08	1159 mm	-	2x4020lm	2x4160lm	2x4400lm	2x4400lm	2x24.0W	2x24.8W
R70S1.DM.CCC.xx-09	1301 mm	-	n.a.***	2x4680lm	2x4950lm	n.a.***	2x27.0W	2x27.9W
R70S1.DM.CCC.xx-10	1441 mm	-	2x5025lm	2x5200lm	2x5500lm	2x5500lm	2x30.0W	2x31.0W
R70S1.DM.CCC.xx-11	1583 mm	-	n.a.***	2x5720lm	2x6050lm	n.a.***	2x33.0W	2x34.1W
R70S1.DM.CCC.xx-12	1721 mm	-	2x6030lm	2x6240lm	2x6600lm	2x6600lm	2x36.0W	2x37.2W
R70S1.DM.CCC.xx-13	1863 mm	-	n.a.***	2x6760lm	2x7150lm	n.a.***	2x39.0W	2x40.3W
R70S1.DM.CCC.xx-14	2002 mm	-	2x7035lm	2x7280lm	2x7700lm	2x7700lm	2x42.0W	2x43.4W
R70S1.DM.CCC.xx-15	2144 mm	-	n.a.***	2x7800lm	2x8250lm	n.a.***	2x45.0W	2x46.5W
R70S1.DM.CCC.xx-16	2282 mm	-	2x8040lm	2x8320lm	2x8800lm	2x8800lm	2x48.0W	2x49.6W
R70S1.DM.CCC.xx-17	2424 mm	-	n.a.***	2x8840lm	2x9350lm	n.a.***	2x51.0W	2x52.7W
R70S1.DM.CCC.xx-18	2564 mm	-	2x9045lm	2x9360lm	2x9900lm	2x9900lm	2x54.0W	2x55.8W
R70S1.DM.CCC.xx-19	2706 mm	-	n.a.***	2x9880lm	2x10450lm	n.a.***	2x57.0W	2x58.9W
R70S1.DM.CCC.xx-20	2844 mm	-	2x10050lm	2x10400lm	2x11000lm	2x11000lm	2x60.0W	2x62.0W
R70S1.DM.CCC.xx-21	2986 mm	-	n.a.***	2x10920lm	2x11550lm	n.a.***	2x63.0W	2x65.1W
R70S1.DM.CCC.xx-22	3125 mm	-	2x11055lm	2x11440lm	2x12100lm	2x12100lm	2x66.0W	2x68.2W
R70S1.DM.CCC.xx-23	3267 mm	-	n.a.***	2x11960lm	2x12650lm	n.a.***	2x69.0W	2x71.3W
R70S1.DM.CCC.xx-24	3405 mm	-	2x12060lm	2x12480lm	2x13200lm	2x13200lm	2x72.0W	2x74.4W
R70S1.DM.CCC.xx-25	3548 mm	1701+1843 mm	n.a.***	2x13000lm	2x13750lm	n.a.***	2x75.0W	2x77.5W
R70S1.DM.CCC.xx-26	3687 mm	1701+1982 mm	2x13065lm	2x13520lm	2x14300lm	2x14300lm	2x78.0W	2x80.6W
R70S1.DM.CCC.xx-27	3829 mm	1843+1982 mm	n.a.***	2x14040lm	2x14850lm	n.a.***	2x81.0W	2x83.7W
R70S1.DM.CCC.xx-28	3968 mm	1982+1982 mm	2x14070lm	2x14560lm	2x15400lm	2x15400lm	2x84.0W	2x86.8W
R70S1.DM.CCC.xx-29	4110 mm	1982+2125 mm	n.a.***	2x15080lm	2x15950lm	n.a.***	2x87.0W	2x89.9W
R70S1.DM.CCC.xx-30	4248 mm	1982+2262 mm	2x15075lm	2x15600lm	2x16500lm	2x16500lm	2x90.0W	2x93.0W
R70S1.DM.CCC.xx-31	4390 mm	2125+2262 mm	n.a.***	2x16120lm	2x17050lm	n.a.***	2x93.0W	2x96.1W
R70S1.DM.CCC.xx-32	4528 mm	2262+2262 mm	2x16080lm	2x16640lm	2x17600lm	2x17600lm	2x96.0W	2x99.2W
R70S1.DM.CCC.xx-33	4670 mm	2262+2405 mm	n.a.***	2x17160lm	2x18150lm	n.a.***	2x99.0W	2x102.3W
R70S1.DM.CCC.xx-34	4810 mm	2262+2544 mm	2x17085lm	2x17680lm	2x18700lm	2x18700lm	2x102.0W	2x105.4W
R70S1.DM.CCC.xx-35	4952 mm	2405+2544 mm	n.a.***	2x18200lm	2x19250lm	n.a.***	2x105.0W	2x108.5W
R70S1.DM.CCC.xx-36	5091 mm	2544+2544 mm	2x18090lm	2x18720lm	2x19800lm	2x19800lm	2x108.0W	2x111.6W
R70S1.DM.CCC.xx-37	5233 mm	2544+2686 mm	n.a.***	2x19240lm	2x20350lm	n.a.***	2x111.0W	2x114.7W
R70S1.DM.CCC.xx-38	5371 mm	2544+2824 mm	2x19095lm	2x19760lm	2x20900lm	2x20900lm	2x114.0W	2x117.8W
R70S1.DM.CCC.xx-39	5513 mm	2544+2966 mm	n.a.***	2x20280lm	2x21450lm	n.a.***	2x117.0W	2x120.9W
R70S1.DM.CCC.xx-40	5653 mm	2544+3105 mm	2x20100lm	2x20800lm	2x22000lm	2x22000lm	2x120.0W	2x124.0W
R70S1.DM.CCC.xx-41	5795 mm	2544+3248 mm	n.a.***	2x21320lm	2x22550lm	n.a.***	2x123.0W	2x127.1W
R70S1.DM.CCC.xx-42	5933 mm	2824+3105 mm	2x21105lm	2x21840lm	2x23100lm	2x23100lm	2x126.0W	2x130.2W
R70S1.DM.CCC.xx-43	6075 mm	2966+3105 mm	n.a.***	2x22360lm	2x23650lm	n.a.***	2x129.0W	2x133.3W
R70S1.DM.CCC.xx-44	6214 mm	3105+3105 mm	2x22110lm	2x22880lm	2x24200lm	2x24200lm	2x132.0W	2x136.4W
R70S1.DM.CCC.xx-45	6356 mm	3105+3248 mm	n.a.***	2x23400lm	2x24750lm	n.a.***	2x135.0W	2x139.5W
R70S1.DM.CCC.xx-46	6494 mm	3105+3385 mm	2x23115lm	2x23920lm	2x25300lm	2x25300lm	2x138.0W	2x142.6W
R70S1.DM.CCC.xx-47	6636 mm	3248+3385 mm	n.a.***	2x24440lm	2x25850lm	n.a.***	2x141.0W	2x145.7W
R70S1.DM.CCC.xx-48	6774 mm	3385+3385 mm	2x24120lm	2x24960lm	2x26400lm	2x26400lm	2x144.0W	2x148.8W

* Luminous flux mentioned is the flux of the LED modules. To know the luminous flux of the luminaire, please apply the light output ratios on page 337 or check www.doxis.be.

** Power mentioned is for LED module excl. driver. For Tunable White power consumption please check www.doxis.be. For more detailed information, please check www.doxis.be.

*** Not available. Our supplier, Philips, does not provide 140mm LED modules in 2700K and Tunable White.

Article number structure: **R70S1.DM.CCC.xx-00**

- 24:** Non dimmable
- 25:** 1-10V dimmable
- 26:** Touch & DALI dim

- 830:** Ra80 - 3000K
- 840:** Ra80 - 4000K
- 927:** Ra90 - 2700K
- 930:** Ra90 - 3000K
- 940:** Ra90 - 4000K
- TW:** Tunable white 2700K-6500K

- 01:** White Matt Texture
- 03:** Black Matt Texture
- 05:** White + Black Text.
- 18:** Grey 9006 Matt Text.
- 28:** Grey + Black Matt Text.
- 07:** Anthracite Matt Text.
- 25:** Smoked Brown Matt Text.

- 16:** Gold incl. gold grid
 - 11:** Black + Gold
 - 32:** Gold + Black
 - 12:** White + Gold incl gold grid
- Other colors on request (see page 333)

Ready To Go LEDliner70

UGR<19

Up&Down - Suspended
Double Circuit

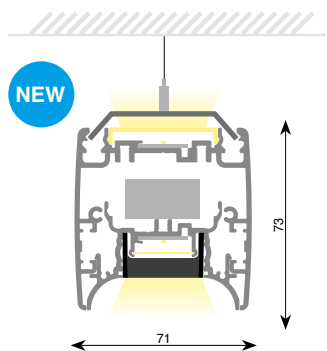

Average weight of equipped profile: 4.3 kg/m

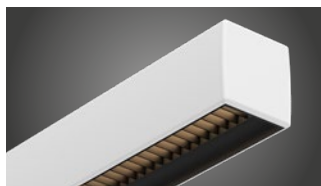

!!! Important notice regarding
Double Circuit dimming on page 342.

Included

- Profile
- End Caps
- LED Modules
- UGR Grid Down
- Opal cover up
- Standard Suspension (2000mm)
- Connecting box
- Textile power cable (2000mm)



Article number	Total length	Connected profile lengths excl. end caps	LED Flux* 927	LED Flux* 830 & 930	LED Flux* 840 & 940	LED Flux* Tunable White 2700-6500K	Power** 830 & 840	Power** 927, 930 & 940
R70S2.DM.CCC.xx-05.G	740 mm	-	n.a.***	2x3120lm	2x3300lm	n.a.***	2x15.0W	2x15.5W
R70S2.DM.CCC.xx-06.G	879 mm	-	2x3015lm	2x3120lm	2x3300lm	2x3300lm	2x18.0W	2x18.6W
R70S2.DM.CCC.xx-07.G	1021 mm	-	n.a.***	2x3640lm	2x3850lm	n.a.***	2x21.0W	2x21.7W
R70S2.DM.CCC.xx-08.G	1159 mm	-	2x4020lm	2x4160lm	2x4400lm	2x4400lm	2x24.0W	2x24.8W
R70S2.DM.CCC.xx-09.G	1301 mm	-	n.a.***	2x4680lm	2x4950lm	n.a.***	2x27.0W	2x27.9W
R70S2.DM.CCC.xx-10.G	1441 mm	-	2x5025lm	2x5200lm	2x5500lm	2x5500lm	2x30.0W	2x31.0W
R70S2.DM.CCC.xx-11.G	1583 mm	-	n.a.***	2x5720lm	2x6050lm	n.a.***	2x33.0W	2x34.1W
R70S2.DM.CCC.xx-12.G	1721 mm	-	2x6030lm	2x6240lm	2x6600lm	2x6600lm	2x36.0W	2x37.2W
R70S2.DM.CCC.xx-13.G	1863 mm	-	n.a.***	2x6760lm	2x7150lm	n.a.***	2x39.0W	2x40.3W
R70S2.DM.CCC.xx-14.G	2002 mm	-	2x7035lm	2x7280lm	2x7700lm	2x7700lm	2x42.0W	2x43.4W
R70S2.DM.CCC.xx-15.G	2144 mm	-	n.a.***	2x7800lm	2x8250lm	n.a.***	2x45.0W	2x46.5W
R70S2.DM.CCC.xx-16.G	2282 mm	-	2x8040lm	2x8320lm	2x8800lm	2x8800lm	2x48.0W	2x49.6W
R70S2.DM.CCC.xx-17.G	2424 mm	-	n.a.***	2x8840lm	2x9350lm	n.a.***	2x51.0W	2x52.7W
R70S2.DM.CCC.xx-18.G	2564 mm	-	2x9045lm	2x9360lm	2x9900lm	2x9900lm	2x54.0W	2x55.8W
R70S2.DM.CCC.xx-19.G	2706 mm	-	n.a.***	2x9880lm	2x10450lm	n.a.***	2x57.0W	2x58.9W
R70S2.DM.CCC.xx-20.G	2844 mm	-	2x10050lm	2x10400lm	2x11000lm	2x11000lm	2x60.0W	2x62.0W
R70S2.DM.CCC.xx-21.G	2986 mm	-	n.a.***	2x10920lm	2x11550lm	n.a.***	2x63.0W	2x65.1W
R70S2.DM.CCC.xx-22.G	3125 mm	-	2x11055lm	2x11440lm	2x12100lm	2x12100lm	2x66.0W	2x68.2W
R70S2.DM.CCC.xx-23.G	3267 mm	-	n.a.***	2x11960lm	2x12650lm	n.a.***	2x69.0W	2x71.3W
R70S2.DM.CCC.xx-24.G	3405 mm	-	2x12060lm	2x12480lm	2x13200lm	2x13200lm	2x72.0W	2x74.4W
R70S2.DM.CCC.xx-25.G	3548 mm	1701+1843 mm	n.a.***	2x13000lm	2x13750lm	n.a.***	2x75.0W	2x77.5W
R70S2.DM.CCC.xx-26.G	3687 mm	1701+1982 mm	2x13065lm	2x13520lm	2x14300lm	2x14300lm	2x78.0W	2x80.6W
R70S2.DM.CCC.xx-27.G	3829 mm	1843+1982 mm	n.a.***	2x14040lm	2x14850lm	n.a.***	2x81.0W	2x83.7W
R70S2.DM.CCC.xx-28.G	3968 mm	1982+1982 mm	2x14070lm	2x14560lm	2x15400lm	2x15400lm	2x84.0W	2x86.8W
R70S2.DM.CCC.xx-29.G	4110 mm	1982+2125 mm	n.a.***	2x15080lm	2x15950lm	n.a.***	2x87.0W	2x89.9W
R70S2.DM.CCC.xx-30.G	4248 mm	1982+2262 mm	2x15075lm	2x15600lm	2x16500lm	2x16500lm	2x90.0W	2x93.0W
R70S2.DM.CCC.xx-31.G	4390 mm	2125+2262 mm	n.a.***	2x16120lm	2x17050lm	n.a.***	2x93.0W	2x96.1W
R70S2.DM.CCC.xx-32.G	4528 mm	2262+2262 mm	2x16080lm	2x16640lm	2x17600lm	2x17600lm	2x96.0W	2x99.2W
R70S2.DM.CCC.xx-33.G	4670 mm	2262+2405 mm	n.a.***	2x17160lm	2x18150lm	n.a.***	2x99.0W	2x102.3W
R70S2.DM.CCC.xx-34.G	4810 mm	2262+2544 mm	2x17085lm	2x17680lm	2x18700lm	2x18700lm	2x102.0W	2x105.4W
R70S2.DM.CCC.xx-35.G	4952 mm	2405+2544 mm	n.a.***	2x18200lm	2x19250lm	n.a.***	2x105.0W	2x108.5W
R70S2.DM.CCC.xx-36.G	5091 mm	2544+2544 mm	2x18090lm	2x18720lm	2x19800lm	2x19800lm	2x108.0W	2x111.6W
R70S2.DM.CCC.xx-37.G	5233 mm	2544+2686 mm	n.a.***	2x19240lm	2x20350lm	n.a.***	2x111.0W	2x114.7W
R70S2.DM.CCC.xx-38.G	5371 mm	2544+2824 mm	2x19095lm	2x19760lm	2x20900lm	2x20900lm	2x114.0W	2x117.8W
R70S2.DM.CCC.xx-39.G	5513 mm	2544+2966 mm	n.a.***	2x20280lm	2x21450lm	n.a.***	2x117.0W	2x120.9W
R70S2.DM.CCC.xx-40.G	5653 mm	2544+3105 mm	2x20100lm	2x20800lm	2x22000lm	2x22000lm	2x120.0W	2x124.0W
R70S2.DM.CCC.xx-41.G	5795 mm	2544+3248 mm	n.a.***	2x21320lm	2x22550lm	n.a.***	2x123.0W	2x127.1W
R70S2.DM.CCC.xx-42.G	5933 mm	2824+3105 mm	2x21105lm	2x21840lm	2x23100lm	2x23100lm	2x126.0W	2x130.2W
R70S2.DM.CCC.xx-43.G	6075 mm	2966+3105 mm	n.a.***	2x22360lm	2x23650lm	n.a.***	2x129.0W	2x133.3W
R70S2.DM.CCC.xx-44.G	6214 mm	3105+3105 mm	2x22110lm	2x22880lm	2x24200lm	2x24200lm	2x132.0W	2x136.4W
R70S2.DM.CCC.xx-45.G	6356 mm	3105+3248 mm	n.a.***	2x23400lm	2x24750lm	n.a.***	2x135.0W	2x139.5W
R70S2.DM.CCC.xx-46.G	6494 mm	3105+3385 mm	2x23115lm	2x23920lm	2x25300lm	2x25300lm	2x138.0W	2x142.6W
R70S2.DM.CCC.xx-47.G	6636 mm	3248+3385 mm	n.a.***	2x24440lm	2x25850lm	n.a.***	2x141.0W	2x145.7W
R70S2.DM.CCC.xx-48.G	6774 mm	3385+3385 mm	2x24120lm	2x24960lm	2x26400lm	2x26400lm	2x144.0W	2x148.8W

* Luminous flux mentioned is the flux of the LED modules. To know the luminous flux of the luminaire, please apply the light output ratios on page 337 or check www.doxis.be.

** Power mentioned is for LED module excl. driver. For Tunable White power consumption please check www.doxis.be. For more detailed information, please check www.doxis.be

*** Not available. Our supplier, Philips, does not provide 140mm LED modules in 2700K and Tunable White.

Article number structure: **R70S2.DM.CCC.xx-00**

- 24: Non dimmable
- 25: 1-10V dimmable
- 26: Touch & DALI dim

- 830: Ra80 - 3000K
 - 840: Ra80 - 4000K
 - 927: Ra90 - 2700K
 - 930: Ra90 - 3000K
 - 940: Ra90 - 4000K
 - TW: Tunable white 2700K-6500K
- 927 & TW available in limited lengths

- 01: White Matt Texture
- 03: Black Matt Texture
- 05: White + Black Text.
- 18: Grey 9006 Matt Text.
- 28: Grey + Black Matt Text.
- 07: Anthracite Matt Text.
- 25: Smoked Brown Matt Text.

- 16: Gold incl. gold grid
 - 11: Black + Gold
 - 32: Gold + Black
 - 12: White + Gold incl gold grid
- Other colors on request (see page 333)

Ready To Go LEDliner70

Opal Cover
Up&Down - Suspended
Double Circuit

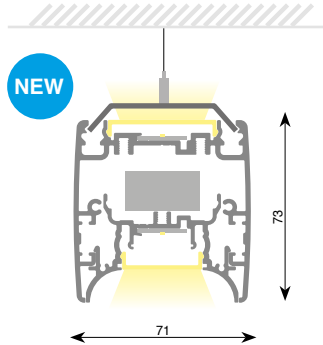

Average weight of equipped profile: 4.3 kg/m

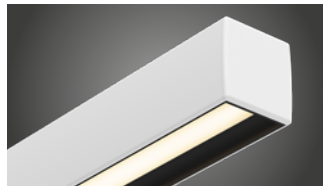

!!! Important notice regarding
Double Circuit dimming on page 342.

Included

- Profile
- End Caps
- LED Modules
- PC cover down
- Opal cover up
- Standard Suspension (2000mm)
- Connecting box
- Textile power cable (2000mm)



Article number	Total length	Connected profile lengths excl. end caps	LED Flux* 927	LED Flux* 830 & 930	LED Flux* 840 & 940	LED Flux* Tunable White 2700-6500K	Power** 830 & 840	Power** 927, 930 & 940
R70S2.DM.CCC.xx-05	740 mm	-	n.a.***	2x3120lm	2x3300lm	n.a.***	2x15.0W	2x15.5W
R70S2.DM.CCC.xx-06	879 mm	-	2x3015lm	2x3120lm	2x3300lm	2x3300lm	2x18.0W	2x18.6W
R70S2.DM.CCC.xx-07	1021 mm	-	n.a.***	2x3640lm	2x3850lm	n.a.***	2x21.0W	2x21.7W
R70S2.DM.CCC.xx-08	1159 mm	-	2x4020lm	2x4160lm	2x4400lm	2x4400lm	2x24.0W	2x24.8W
R70S2.DM.CCC.xx-09	1301 mm	-	n.a.***	2x4680lm	2x4950lm	n.a.***	2x27.0W	2x27.9W
R70S2.DM.CCC.xx-10	1441 mm	-	2x5025lm	2x5200lm	2x5500lm	2x5500lm	2x30.0W	2x31.0W
R70S2.DM.CCC.xx-11	1583 mm	-	n.a.***	2x5720lm	2x6050lm	n.a.***	2x33.0W	2x34.1W
R70S2.DM.CCC.xx-12	1721 mm	-	2x6030lm	2x6240lm	2x6600lm	2x6600lm	2x36.0W	2x37.2W
R70S2.DM.CCC.xx-13	1863 mm	-	n.a.***	2x6760lm	2x7150lm	n.a.***	2x39.0W	2x40.3W
R70S2.DM.CCC.xx-14	2002 mm	-	2x7035lm	2x7280lm	2x7700lm	2x7700lm	2x42.0W	2x43.4W
R70S2.DM.CCC.xx-15	2144 mm	-	n.a.***	2x7800lm	2x8250lm	n.a.***	2x45.0W	2x46.5W
R70S2.DM.CCC.xx-16	2282 mm	-	2x8040lm	2x8320lm	2x8800lm	2x8800lm	2x48.0W	2x49.6W
R70S2.DM.CCC.xx-17	2424 mm	-	n.a.***	2x8840lm	2x9350lm	n.a.***	2x51.0W	2x52.7W
R70S2.DM.CCC.xx-18	2564 mm	-	2x9045lm	2x9360lm	2x9900lm	2x9900lm	2x54.0W	2x55.8W
R70S2.DM.CCC.xx-19	2706 mm	-	n.a.***	2x9880lm	2x10450lm	n.a.***	2x57.0W	2x58.9W
R70S2.DM.CCC.xx-20	2844 mm	-	2x10050lm	2x10400lm	2x11000lm	2x11000lm	2x60.0W	2x62.0W
R70S2.DM.CCC.xx-21	2986 mm	-	n.a.***	2x10920lm	2x11550lm	n.a.***	2x63.0W	2x65.1W
R70S2.DM.CCC.xx-22	3125 mm	-	2x11055lm	2x11440lm	2x12100lm	2x12100lm	2x66.0W	2x68.2W
R70S2.DM.CCC.xx-23	3267 mm	-	n.a.***	2x11960lm	2x12650lm	n.a.***	2x69.0W	2x71.3W
R70S2.DM.CCC.xx-24	3405 mm	-	2x12060lm	2x12480lm	2x13200lm	2x13200lm	2x72.0W	2x74.4W
R70S2.DM.CCC.xx-25	3548 mm	1701+1843 mm	n.a.***	2x13000lm	2x13750lm	n.a.***	2x75.0W	2x77.5W
R70S2.DM.CCC.xx-26	3687 mm	1701+1982 mm	2x13065lm	2x13520lm	2x14300lm	2x14300lm	2x78.0W	2x80.6W
R70S2.DM.CCC.xx-27	3829 mm	1843+1982 mm	n.a.***	2x14040lm	2x14850lm	n.a.***	2x81.0W	2x83.7W
R70S2.DM.CCC.xx-28	3968 mm	1982+1982 mm	2x14070lm	2x14560lm	2x15400lm	2x15400lm	2x84.0W	2x86.8W
R70S2.DM.CCC.xx-29	4110 mm	1982+2125 mm	n.a.***	2x15080lm	2x15950lm	n.a.***	2x87.0W	2x89.9W
R70S2.DM.CCC.xx-30	4248 mm	1982+2262 mm	2x15075lm	2x15600lm	2x16500lm	2x16500lm	2x90.0W	2x93.0W
R70S2.DM.CCC.xx-31	4390 mm	2125+2262 mm	n.a.***	2x16120lm	2x17050lm	n.a.***	2x93.0W	2x96.1W
R70S2.DM.CCC.xx-32	4528 mm	2262+2262 mm	2x16080lm	2x16640lm	2x17600lm	2x17600lm	2x96.0W	2x99.2W
R70S2.DM.CCC.xx-33	4670 mm	2262+2405 mm	n.a.***	2x17160lm	2x18150lm	n.a.***	2x99.0W	2x102.3W
R70S2.DM.CCC.xx-34	4810 mm	2262+2544 mm	2x17085lm	2x17680lm	2x18700lm	2x18700lm	2x102.0W	2x105.4W
R70S2.DM.CCC.xx-35	4952 mm	2405+2544 mm	n.a.***	2x18200lm	2x19250lm	n.a.***	2x105.0W	2x108.5W
R70S2.DM.CCC.xx-36	5091 mm	2544+2544 mm	2x18090lm	2x18720lm	2x19800lm	2x19800lm	2x108.0W	2x111.6W
R70S2.DM.CCC.xx-37	5233 mm	2544+2686 mm	n.a.***	2x19240lm	2x20350lm	n.a.***	2x111.0W	2x114.7W
R70S2.DM.CCC.xx-38	5371 mm	2544+2824 mm	2x19095lm	2x19760lm	2x20900lm	2x20900lm	2x114.0W	2x117.8W
R70S2.DM.CCC.xx-39	5513 mm	2544+2966 mm	n.a.***	2x20280lm	2x21450lm	n.a.***	2x117.0W	2x120.9W
R70S2.DM.CCC.xx-40	5653 mm	2544+3105 mm	2x20100lm	2x20800lm	2x22000lm	2x22000lm	2x120.0W	2x124.0W
R70S2.DM.CCC.xx-41	5795 mm	2544+3248 mm	n.a.***	2x21320lm	2x22550lm	n.a.***	2x123.0W	2x127.1W
R70S2.DM.CCC.xx-42	5933 mm	2824+3105 mm	2x21105lm	2x21840lm	2x23100lm	2x23100lm	2x126.0W	2x130.2W
R70S2.DM.CCC.xx-43	6075 mm	2966+3105 mm	n.a.***	2x22360lm	2x23650lm	n.a.***	2x129.0W	2x133.3W
R70S2.DM.CCC.xx-44	6214 mm	3105+3105 mm	2x22110lm	2x22880lm	2x24200lm	2x24200lm	2x132.0W	2x136.4W
R70S2.DM.CCC.xx-45	6356 mm	3105+3248 mm	n.a.***	2x23400lm	2x24750lm	n.a.***	2x135.0W	2x139.5W
R70S2.DM.CCC.xx-46	6494 mm	3105+3385 mm	2x23115lm	2x23920lm	2x25300lm	2x25300lm	2x138.0W	2x142.6W
R70S2.DM.CCC.xx-47	6636 mm	3248+3385 mm	n.a.***	2x24440lm	2x25850lm	n.a.***	2x141.0W	2x145.7W
R70S2.DM.CCC.xx-48	6774 mm	3385+3385 mm	2x24120lm	2x24960lm	2x26400lm	2x26400lm	2x144.0W	2x148.8W

* Luminous flux mentioned is the flux of the LED modules. To know the luminous flux of the luminaire, please apply the light output ratios on page 337 or check www.doxis.be.

** Power mentioned is for LED module excl. driver. For Tunable White power consumption please check www.doxis.be. For more detailed information, please check www.doxis.be.

*** Not available. Our supplier, Philips, does not provide 140mm LED modules in 2700K and Tunable White.

Article number structure: **R70S2.DM.CCC.xx-00**

- 24: Non dimmable
- 25: 1-10V dimmable
- 26: Touch & DALI dim

- 830: Ra80 - 3000K
- 840: Ra80 - 4000K
- 927: Ra90 - 2700K
- 930: Ra90 - 3000K
- 940: Ra90 - 4000K
- TW: Tunable white 2700K-6500K

- 01: White Matt Texture
- 03: Black Matt Texture
- 05: White + Black Text.
- 18: Grey 9006 Matt Text.
- 28: Grey + Black Matt Text.
- 07: Anthracite Matt Text.
- 25: Smoked Brown Matt Text.

- 16: Gold incl. gold grid
 - 11: Black + Gold
 - 32: Gold + Black
 - 12: White + Gold incl gold grid
- Other colors on request (see page 333)